

## Technical Data Sheet

### Photocoupler-RoHS Compliant

#### Features:

- Current transfer ratio  
(CTR:MIN.50% at IF =5mA ,VCE =5V)
- High isolation voltage between input and output (Viso=5000 V rms )
- Compact dual-in-line package  
EL817\*:1-channel type
- Pb free
- UL approved (No. E214129)
- VDE approved (No. 132249)
- SEMKO approved (No. 608400)
- NEMKO approved (No. PO6206474/A1)
- DEMKO approved (No. 313924-01)
- FIMKO approved (No. FI 22807)
- CSA approved (No. 1143601)
- BSI approved (No. 8592, 8593)
- Options available:
  - Leads with 0.4”(10.16mm) spacing (M Type)
  - Leads bends for surface mounting (S and S1 Type)
  - Tape and Reel of Type I for SMD(Add”TA” Suffix)
  - Tape and Reel of Type II for SMD(Add”TB” Suffix)
  - The tape is 16mm and is wound on a 33cm reel
- The product itself will remain within RoHS compliant version.

#### EL817 Series



**EL817**



**EL817M**



**EL817S**

#### Description

The EL817 series contains a infrared emitting diode optically coupled to a phototransistor. It is packaged in a 4-pin DIP package and available in wide-lead spacing and SMD option.

#### Applications

- Computer terminals
- System appliances, measuring instruments
- Registers, copiers, automatic vending machines
- Signal transmission between circuits of different potentials and impedances

#### Device Selection Guide

Part. No.	Chip Material	
	IR	PT
EL817*	GaAs	Silicon

Technical Data Sheet  
Photocoupler-RoHS Compliant

Package Dimensions

EL817 Series

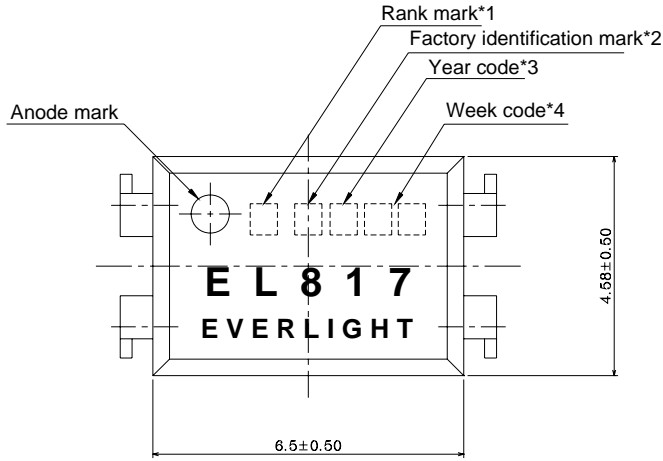

PIN NO. AND INTERNAL CONNECTION DIAGRAM

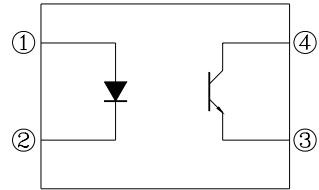

- 1. Anode
- 2. Cathode
- 3. Emitter
- 4. Collector

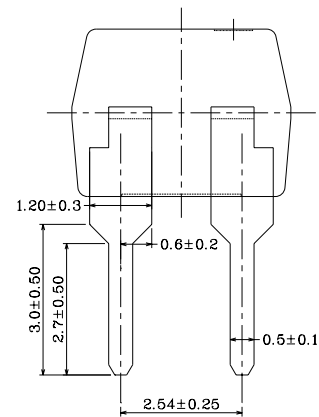
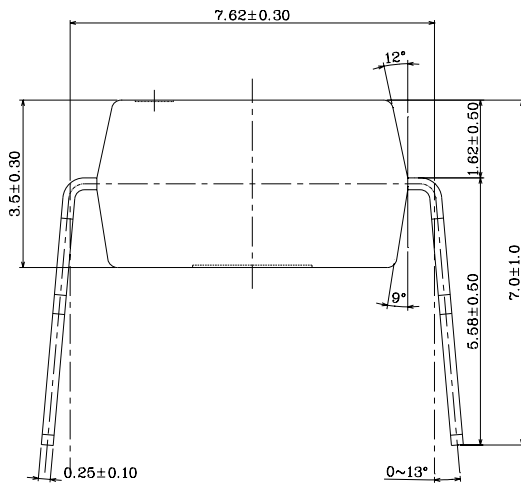

Technical Data Sheet  
Photocoupler-RoHS Compliant

Package Dimensions

EL817 Series

M Type

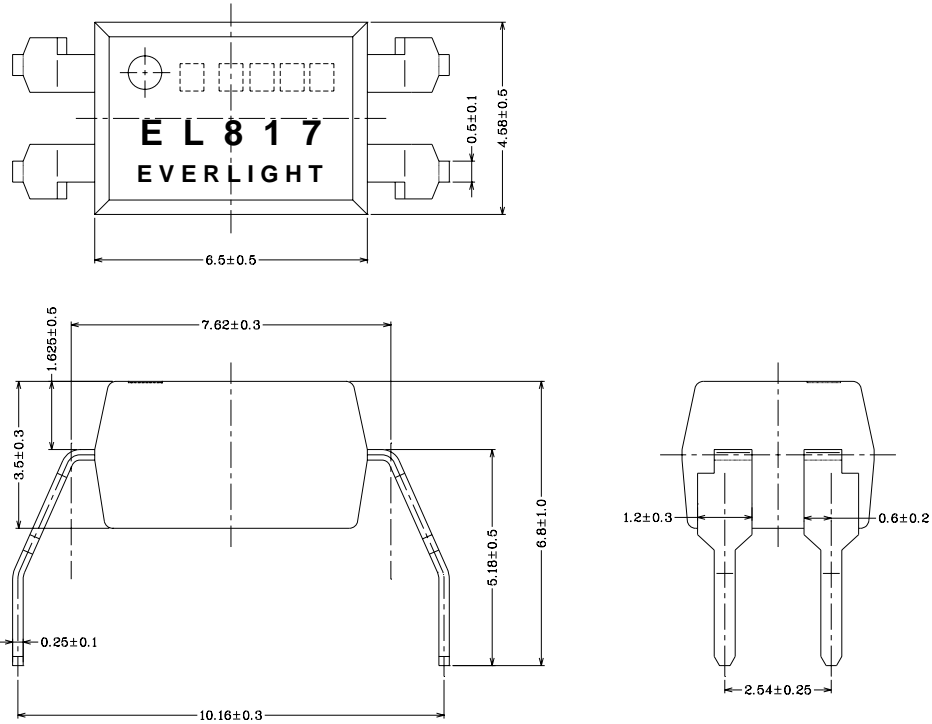

S Type

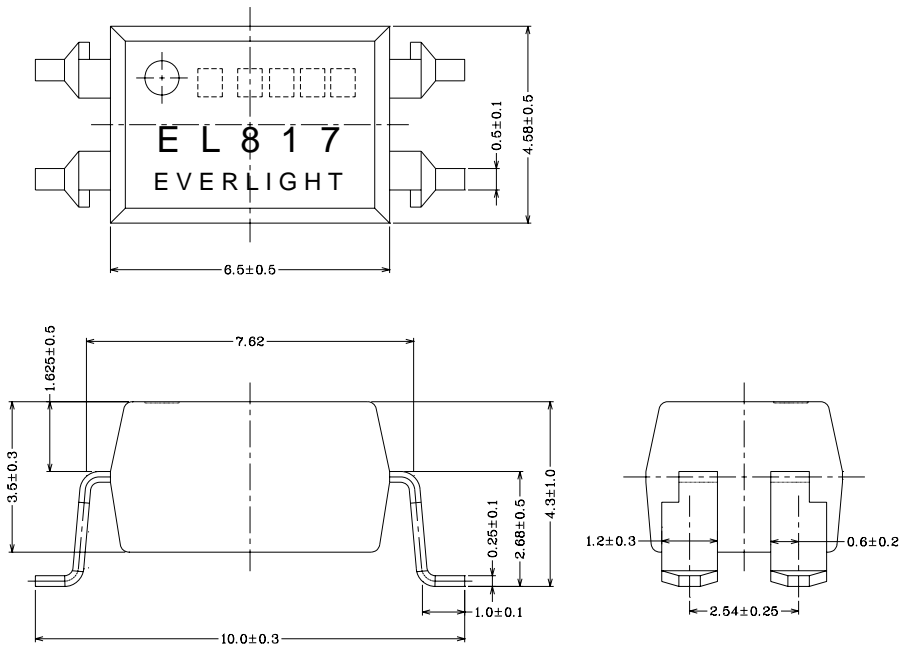

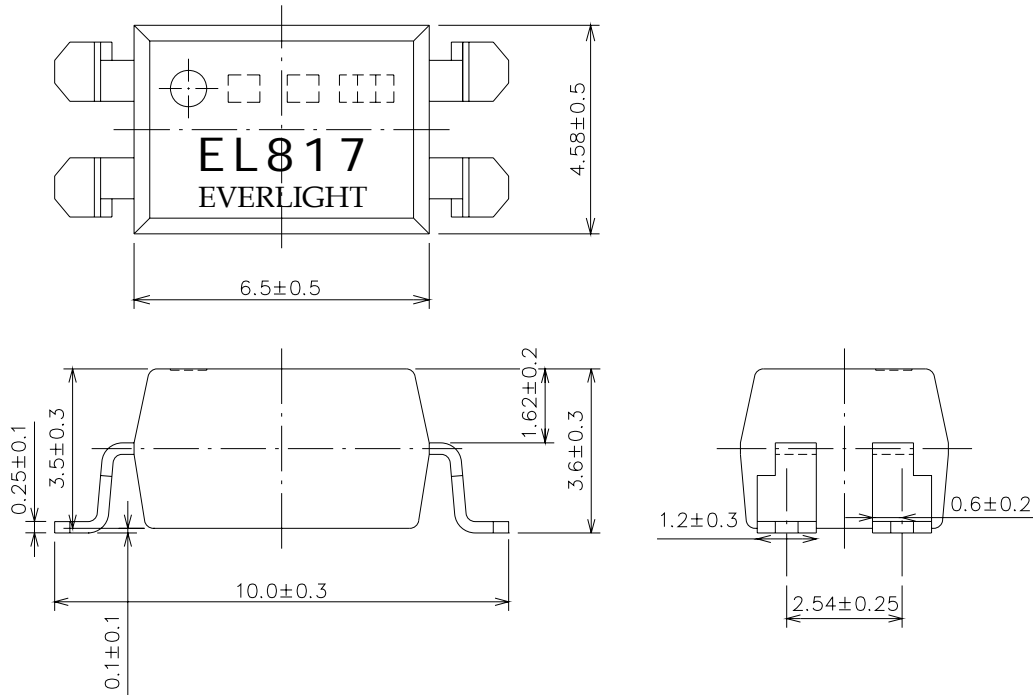
**Technical Data Sheet  
Photocoupler-RoHS Compliant****S1 Type****EL817 Series****Notes:**

1. Rank shall be or shall not be marked
2. Factory code shall be marked (T: Taiwan / C: China)
3. Year date code
4. 2-digit work week
5. All dimensions are in millimeters
6. Specifications are subject to change without notice

**Technical Data Sheet  
Photocoupler-RoHS Compliant**
**EL817 Series**
**Absolute Maximum Ratings**
**( Ta=25°C )**

Parameter		Symbol	Rating	Unit
Input	Forward Current	$I_F$	50	mA
	Peak Forward Current*1	$I_{FM}$	1	A
	Reverse Voltage	$V_R$	6	V
	Power Dissipation	P	70	mW
Output	Collector Power Dissipation	$P_C$	150	mW
	Collector Current	$I_C$	50	mA
	Collector-Emitter Voltage	$V_{CEO}$	35	V
	Emitter-Collector Voltage	$V_{ECO}$	6	V
Total Power Dissipation		$P_{tot}$	200	mW
*2 Isolation Voltage		Viso	5000	V rms
Operating Temperature		Topr	-55~+110	°C
Storage Temperature		Tstg	-55~+125	°C
*3 Soldering Temperature		Tsol	260	°C

\*1 Frequency=100 HZ ,10uS Duty

\*2 AC for 1 minute, R.H= 40~ 60%RH

-Isolation voltage shall be measured using the following method.

- (1) Short between anode and cathode on the primary side and between collector, emitter and base on the secondary side.
- (2) The isolation voltage tester with zero-cross circuit shall be used.
- (3) The waveform of applied voltage shall be a sine wave

\*3 For 10 seconds



# Technical Data Sheet

## Photocoupler-RoHS Compliant

**EL817 Series****Electro-Optical Characteristics**

(Ta=25°C)

Parameter	Symbol	Min.	Typ.	Max.	Unit	Condition	
Input	Forward	V <sub>F</sub>	-	1.2	1.4	V	I <sub>F</sub> =20mA
	Peak Forward Current	V <sub>FM</sub>			3.0	V	I <sub>FM</sub> =0.5A
	Reverse Current	I <sub>R</sub>	-	-	10	uA	V <sub>R</sub> =4V
	Terminal	C <sub>t</sub>	-	30	250	pF	V=0,f=1kHz
Output	Collector Dark current	I <sub>CEO</sub>	-	-	100	nA	V <sub>CE</sub> =20V
	Collector-Emitter breakdown voltage	BV <sub>CEO</sub>	35	-	-	V	I <sub>c</sub> =0.1mA
Transfer Characteristics	Current Transfer ratio	CTR	50	-	600	%	I <sub>F</sub> =5mA, V <sub>CE</sub> =5V
	Collector-Emitter saturation voltage	V <sub>CE(sat)</sub>	-	0.1	0.2	V	I <sub>F</sub> =20mA, I <sub>c</sub> =1 mA
	Isolation resistance	R <sub>ISO</sub>	5×10 <sup>10</sup>	10 <sup>11</sup>	-	Ω	DC500V,40~60%R.H
	Flotation capacitance	C <sub>f</sub>	-	0.6	1.0	pF	V=0, f=1MHz
	Cut-off frequency	f <sub>c</sub>	-	80	-	kHz	V <sub>CE</sub> =5V, I <sub>c</sub> =2 mA R <sub>L</sub> =100Ω, -3dB
	Rise time	t <sub>r</sub>	-	4	18	us	V <sub>CE</sub> =2V I <sub>c</sub> =2mA,R <sub>L</sub> =100Ω
	Fall time	t <sub>f</sub>	-	3	18	us	

**Technical Data Sheet  
Photocoupler-RoHS Compliant**
**Supplement**
**EL817 Series**
**Current Transfer Ratio CTR**

Sub-Model No.	Rank mark	CTR (%)	Condition
EL817* <sup>note 1</sup>		50 to 600	$I_F = 5 \text{ mA}$ $V_{CE} = 5 \text{ V}$ $T_a = 25^\circ\text{C}$
EL817* (L) <sup>note2</sup>	L	50 to 100	
EL817* (A)	A	80 to 160	
EL817* (B)	B	130 to 260	
EL817* (C)	C	200 to 400	
EL817* (D)	D	300 to 600	
EL817* (AB)	A or B	80 to 260	
EL817* (BC)	B or C	130 to 400	
EL817* (CD)	C or D	200 to 600	

Note1. The symbol “ \* “ can be none or S or M by different leads form request

Note2. The symbol “ ( ) ” can be CTR rank

**Technical Data Sheet  
Photocoupler-RoHS Compliant**
**EL817 Series**

Fig. 1 Forward Current vs. Ambient Temperature

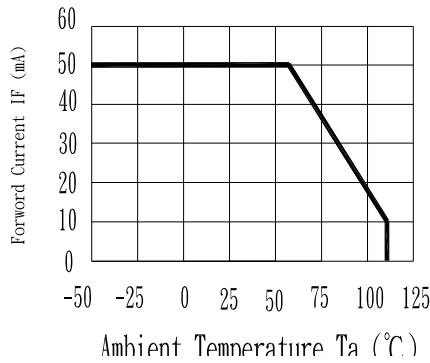

Fig. 2 Collector Power Dissipation vs. Ambient Temperature

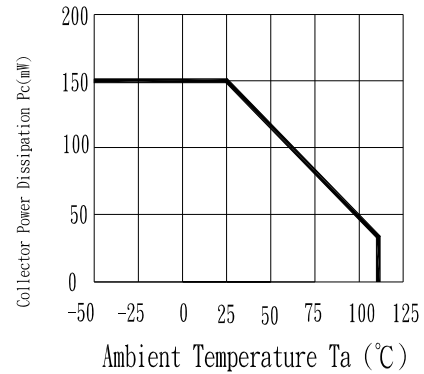
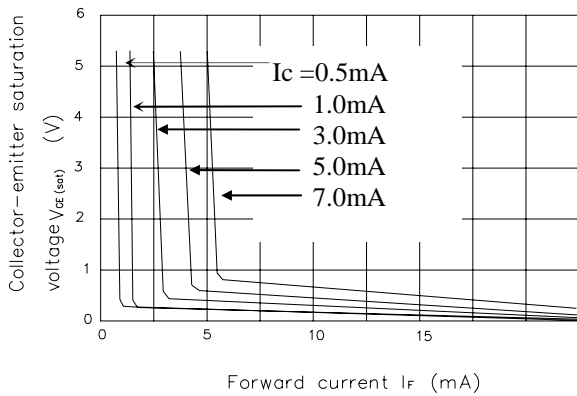

 Fig. 3 Collector-emitter Saturation Voltage vs. Forward Current ( $T_a=25^\circ\text{C}$ )

Fig. 4 Current transfer Ratio vs. Forward Current

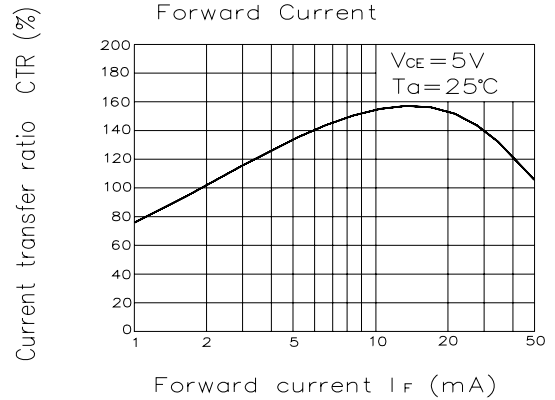
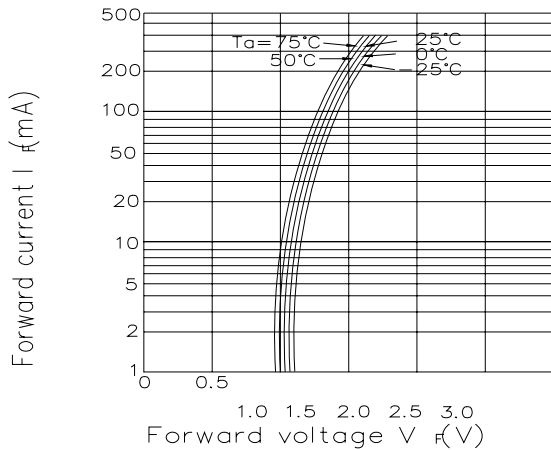
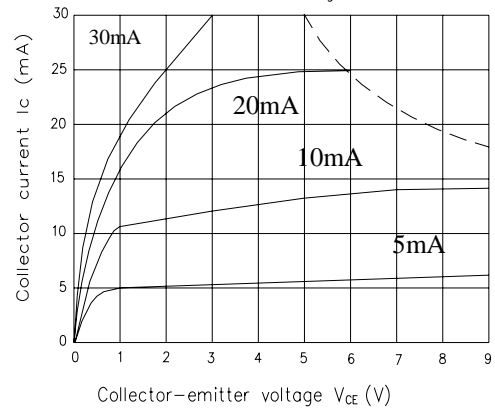

Fig. 5 Forward Current vs. Forward Voltage

 Fig. 6 Collector Current vs. Collector-emitter Voltage ( $T_a=25^\circ\text{C}$ )



Technical Data Sheet  
Photocoupler-RoHS Compliant

**EL817 Series**

Fig.7 Relative Current Transfer Ratio vs Ambient Temperature

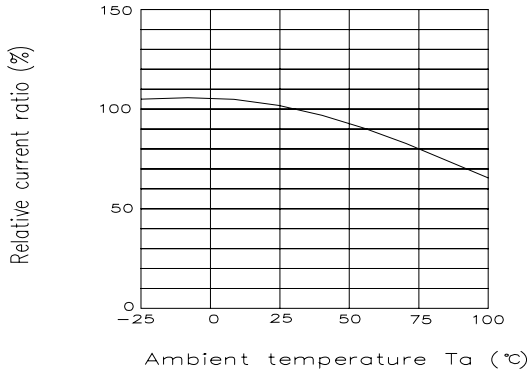

Fig.8 Collector-emitter Saturation Voltage vs. Ambient Temperature

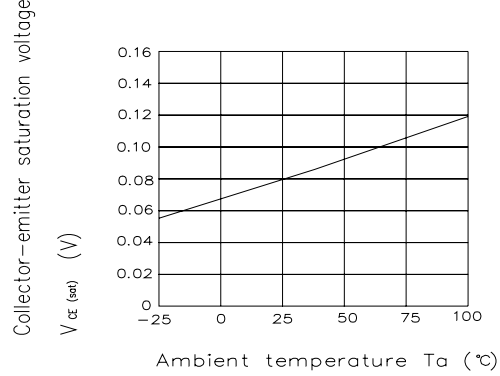

Fig.9 Collector Dark Current vs. Ambient Temperature

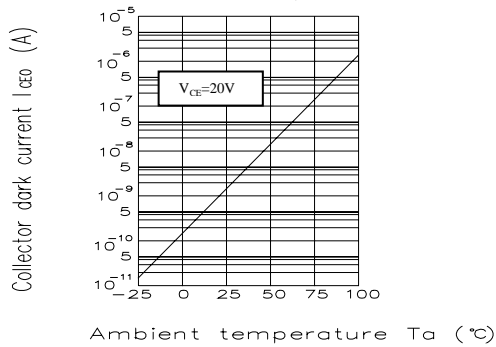

Fig.10 Response Time vs. Load Resistance

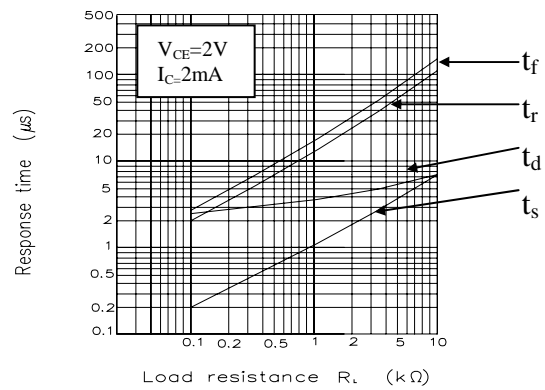

Fig.11 Frequency Response

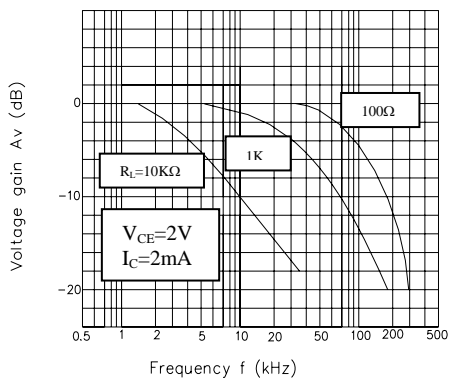
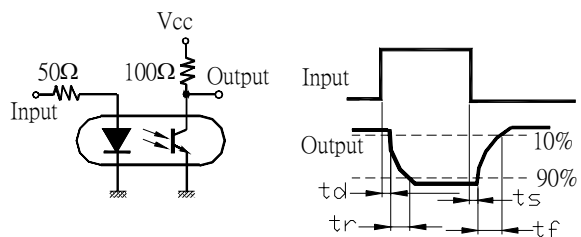

Fig. 12





## Technical Data Sheet

### Photocoupler-RoHS Compliant

#### RELIABILITY PLAN

#### EL817 Series

- The reliability of products shall be satisfied with items listed below.

Confidence level : 90 % , LTPD : 10 %

Classification	Test Item	Description & Condition	(Acc.) Sample	Failure Criteria	Reference Standard
Endurance test	Operation Life *	Ta = 25 ± 3°C IR: If = 50 mA Pt: Pc = 130 mW ( Vf=1.4v) , 1000 hrs	0 / 22		MIL-S-750 : 1026 MIL-S-883 : 1005 JIS C 7021 : B-1
	High Temperature / High Humidity Reverse Bias (H3TRB)	Ta = 85 ± 3°C , Humi. = 85 % rh Pt: 80% * Vce (max rating) , 1000 hrs	0 / 22	CTR shift > 1.2 Vf > U* 1.0 Ir > U * 1.0 Vce(sat) > U*1.0	JIS C 7021 : B-11
	High Temperature Reverse Bias (HTRB)	Ta = 105 ± 3°C Pt: 100% * Vce (Max rating) , 1000 hrs	0 / 22	Bvceo < L*1.0 Bveco < L*1.0	JIS C 7021 : B-8
	Low Temperature Storage	Ta = -50 ± 3°C , 1000 hrs	0 / 22		JIS C 7021 : B-12
	High Temperature Storage	Ta = 125 ± 3°C , 1000 hrs	0 / 22	L :Low Spec.Limit	JIS C 7021 : B-10 MIL-S-883 : 1008
	Autoclave	P = 15 PSIG , Ta = 121 °C , Humi. = 100 % rh , 48 hrs	0 / 22	U : Up Spec.	JESD 22-A102-B
Environmental Test	Temperature Cycling (Air to Air)	125°C ~ - 55 °C 30 ~ 30 min , 100 cycles	0 / 22	Limit	MIL-S-883 :1010 JIS C 7021 : A-4
	Thermal Shock (Liquid to Liquid)	125 ~ - 55°C t (dwell) = 5 min t (trans.) = 10 sec , 100 cycles	0 / 22		MIL-S-202 : 107D MIL-S-750 : 1051 MIL-S-883 :1011
	Solder Resistance	Ta = 260 ± 3°C t (dwell) = 10 ± 1 sec	0 / 22		MIL-S-750 : 2031 JIS C 7021 : A-1
	Solder Ability	Ta = 230 ± 3 °C t (dwell) = 5 ± 1 sec	0 / 22		MIL-S-883 : 2003 JIS C 7021 : A-2

# Technical Data Sheet Photocoupler-RoHS Compliant

Tube Packing Specifications ( For Dip & M Type)

**EL817 Series**

1. Tube

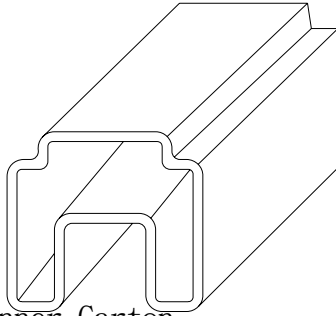

2. Inner Carton

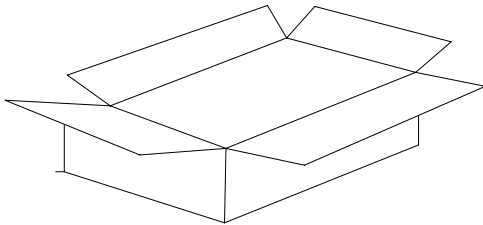

3. Outside Carton

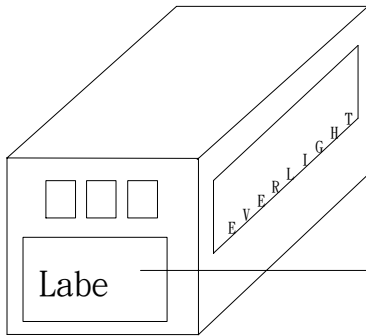

EVERLIGHT

CPN:

P/N:

EL817

QTY:

LOT NO:



RoHS



CAT:

HUE:

REF:

MADE IN TAIWAN



● Packing Quantity

- 1. 100 Pcs/ Per Tube
- 2. 25 Tubes / Inner Carton
- 3. 12 Inner Cartons / Outside Carton

**Technical Data Sheet**  
**Photocoupler-RoHS Compliant**

**Tape & Reel Packing Specifications**

**EL817 Series**

1. Tape & Reel (For S & S1 Type only)

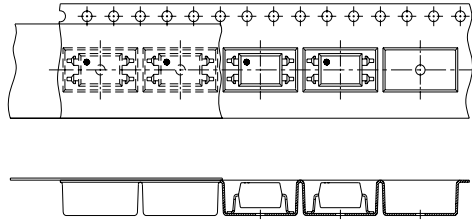
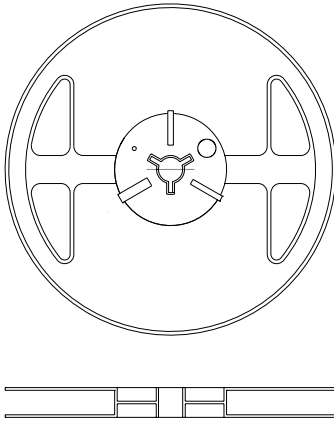

**TA**

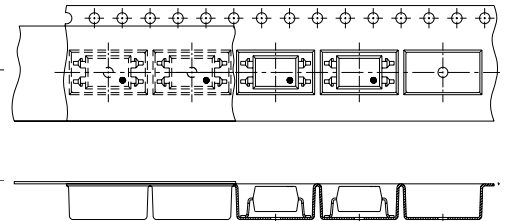

**TB**

2. Inner Carton

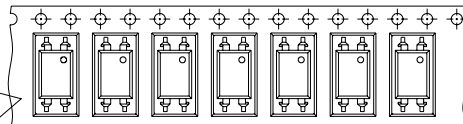
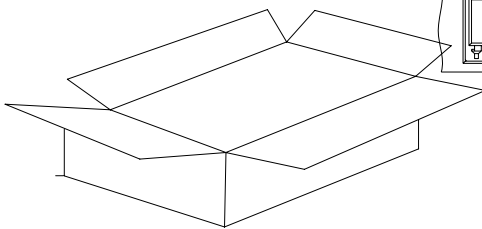

**TU**

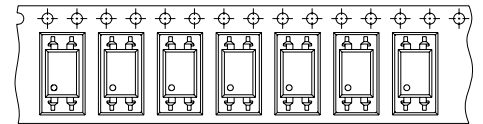

**TD**

3. Outside Carton

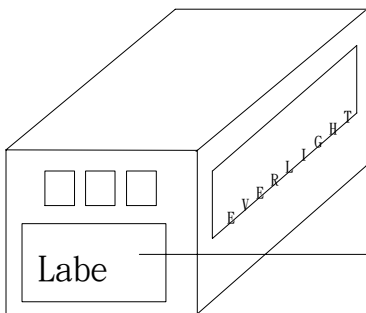

**EVERLIGHT**

CPN:

P/N:

EL817

QTY:

LOT NO:



CAT:

HUE:

REF:

MADE IN TAIWAN



● **Packing Quantity**

1. 1,000 Pcs / Per Reel
2. 3 Reels / Inner Carton
3. 10 Inner Cartons / Outside Carton